

**Individual Beam Output Area Sensor NB Series**

CME-NB20 No.0032-91V

Thank you very much for purchasing Panasonic products. Please read this Instruction Manual carefully and thoroughly for the correct and optimum use of this product. Kindly keep this manual in a convenient place for quick reference.

**⚠ WARNING**

- If this product is used as a sensing device for personnel protection, serious body injury or death could result.
- Never use this product as a sensing device with any press machine, shearing machine, roll grinding machine, forming machine, vulcanizer, or robot etc. for protection of a hand or a part of the body.
- This product does not include a self-checking circuit for safety functions necessary to allow its use as a safety device. Thus, a system failure or malfunction can result in either an energized or a de-energized output condition.
- When this product is used as a sensing device in the following applications and if a problem relating to "law" or "product liability" occurs, Panasonic Industrial Devices SUNX shall not be liable for the failure and for the damage or less.
  - 1) Use of this product installed to a machinery or a device as a sensing device to detect a hand or a part of the operator's body entering a dangerous area and stop the machinery or the device.
  - 2) Installation of this product to a protection device for preventing to enter a dangerous area and use of this as a sensing device which detects a hand or a part of the operator's body and open/close the door or window.
  - 3) Use of this product as a sensing device for personnel protection (including interlock).
- For sensing devices to be used as safety devices for press machines or for personnel protection, use products which meet standards, such as OSHA, ANSI or IEC etc., for personnel protection applicable in each region or country.
- In case of using as a safety device for press machines, use a product approved by the Ministry of Labor in Japan.

**1 OUTLINE**

- This product is 20mm beam pitch area sensor which outputs the beam received / beam interrupted condition of each beam as a serial data.
- By using along with the control board **NB-64CB**, the data output from the sensor can be output separately for each individual beam.

**2 PARTS DESCRIPTION AND FUNCTIONS**

• Area sensor

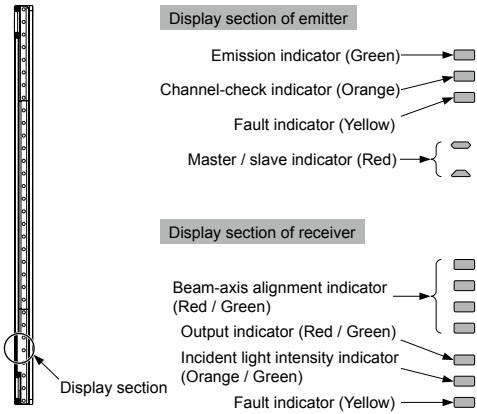

**Emitter**

Description	Function
Emission indicator [EMISSION] (Green)	When light is emitted lights up
Channel-check indicator [CHECK] (Orange)	When channel-checking: lights up
Fault indicator [FAULT] (Yellow)	When fault occurs in the area sensor: blinks or lights up
Master / slave indicator (Red)	When setting master: one indicator lights up When setting slave: two indicators light up

**Receiver**

Description	Function
Beam-axis alignment indicator [RECEPTION] (Red / Green)	Each zone receives light: lights up in red Both end zones receive light: Blinks in red All zones receive light: lights up in green
Output indicator [OUT] (Red / Green)	Light are blocked in one or more: lights up in red All lights are received: brinks in green
Incident light intensity indicator [STB] (Orange / Green)	Stable light is received: lights up in green Unstable light is received: lights up in orange Light is blocked: turns OFF
Fault indicator [FAULT] (Yellow)	Fault occurs in the area sensor or synchronization wire is disconnected: lights up or blinks

Note: The description given in [ ] is marked on the device.

• Control board

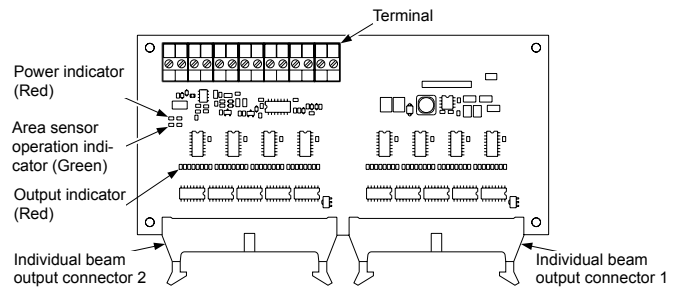

Description	Function
Power indicator (Red)	Lights up when the power is ON.
Area sensor operation indicator (Green)	Lights up when the area sensor works normally.
Output indicators (Red)	Each lights up when the corresponding individual beam output is ON. (64 pcs.)
Terminal	Emitter, receiver, power supply, and interference prevention wires are connected.
Individual beam output connector 1	Output connector for Ch 1 to Ch 32
Individual beam output connector 2	Output connector for Ch 33 to Ch 64

**3 MOUNTING**

- Bottom cap cable is not accessory, order separately.
- The bottom cap cables are distinguished with the color of the connectors, the color of the connector for emitter is gray and that of the receiver is black. be careful when mounting.
- For selecting the appropriate mounting bracket matched to the installation environment, the mounting bracket is not incorporated in this device. Purchase the optional mounting bracket to fit on the mounting environment.
- Do not lose any screws during extension / dismantling work.

**Mounting of the bottom cap cable (optional)**

1. Insert the connector of the bottom cap cable into the connector of this device. When inserting the connector, fit the cable into the groove of this device.

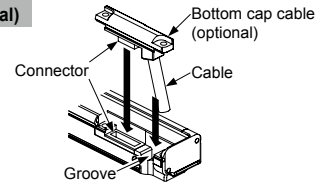

2. Fix the connector of bottom cap cable. and the tightening torque should be 0.3N·m or less.

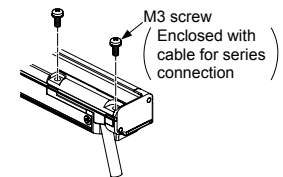

**Mounting of standard mounting bracket MS-SF2B-1 (optional)**

1. In case mounting the mounting bracket to this device, use hexagon-socket head bolts [M3 (length: 5mm)] and the tightening torque should be 0.6N·m or less.

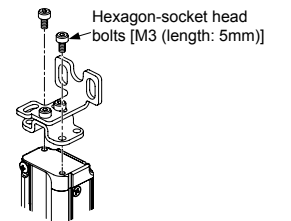

2. In case of side mounting, remove the B part and change the mounting direction. In case changing mounting direction, mount the brackets so that the protrusion of the A part and the B part are overlapped.

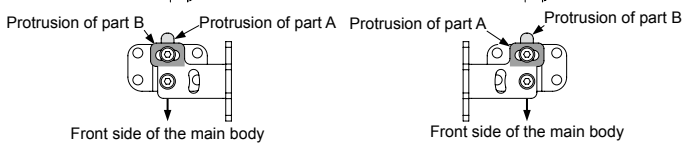
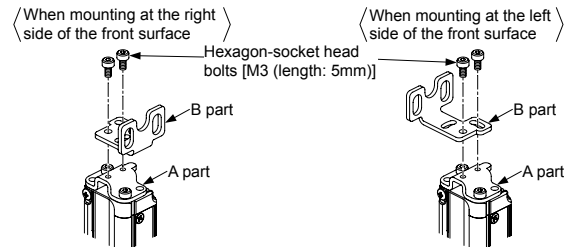

3. Mount temporarily with hexagon-socket head bolts [M5 (purchase separately)] and tighten them after right axis adjustment.

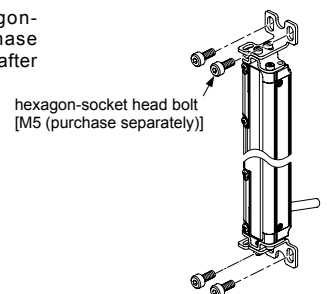

### Mounting of intermediate supporting bracket MS-SF2B-2 (accessory)

1. Hook the C part into the groove on the side of the body and press it.

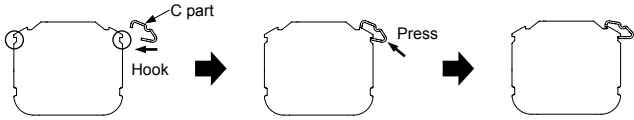

Insert a flathead screwdriver into the hole and tilt it to the rear side of the main body to remove the C part.

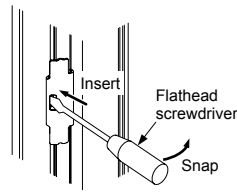

2. Insert the D part or E part into the C part in the step 1 condition.

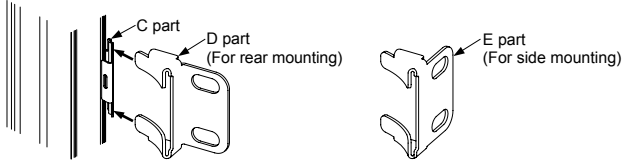

3. Mount the D part on to the mounting surface with the two hexagon-socket head bolts [M5 (purchase separately)].

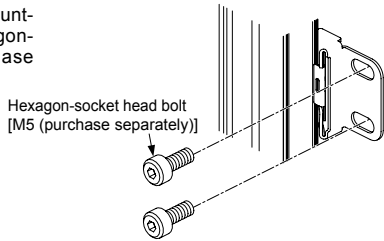

### Mounting of control board NB-64CB

• Use M3 screws when mounting the control board and the tightening torque should be 0.5N·m or less.

## 4 CONNECTOR PIN POSITION ON THE CONTROL BOARD NB-64CB

• Individual beam output connector 1

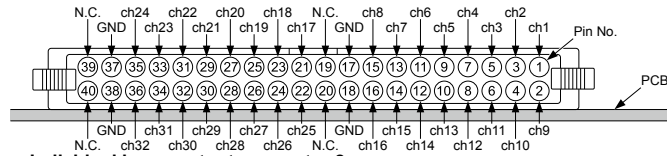

• Individual beam output connector 2

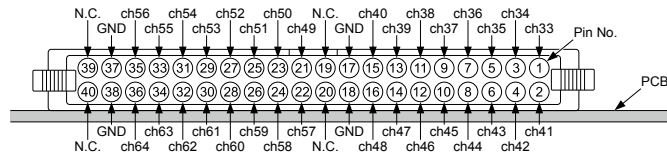

## 5 I/O CIRCUIT DIAGRAMS

• In case using the area sensor only

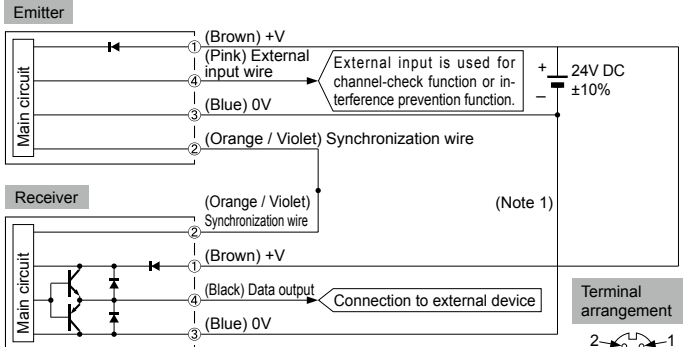

Notes: 1) To supply power to the emitter and the receiver from separate power supplies, be sure to connect both (blue) wires in common and adjust both the power supplies to the same voltage.  
2) Insulate all unused wires individually to avoid miscontact.

• Use with NB-64CB

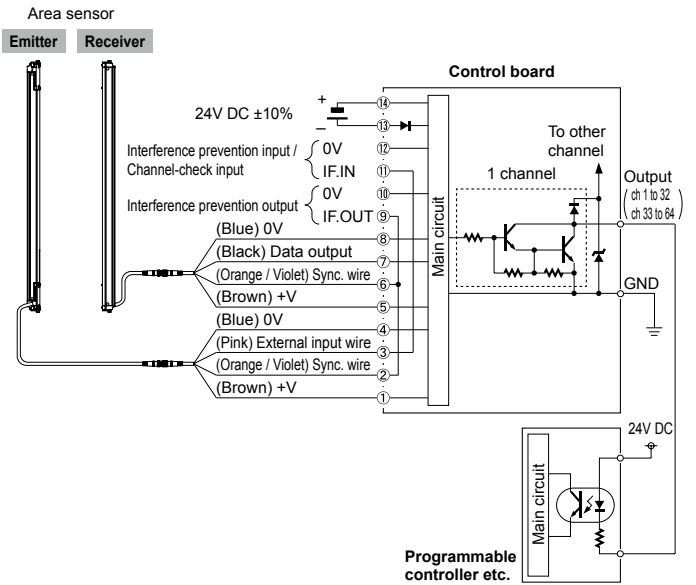

Note: The data output does not incorporate short-circuit protection circuit. Do not connect power supply or capacity stress directly.

## 6 WIRING

• Use area sensor only

Use 1 set only

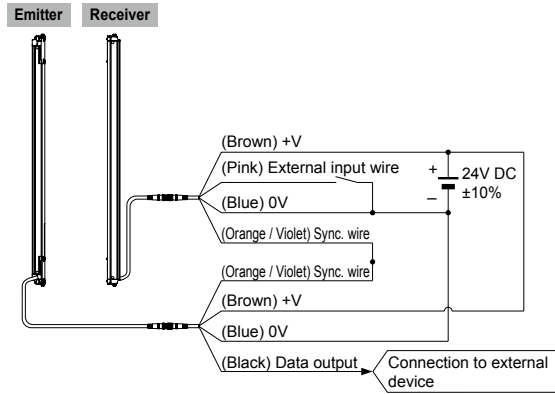

Use 2 sets (using interference prevention)

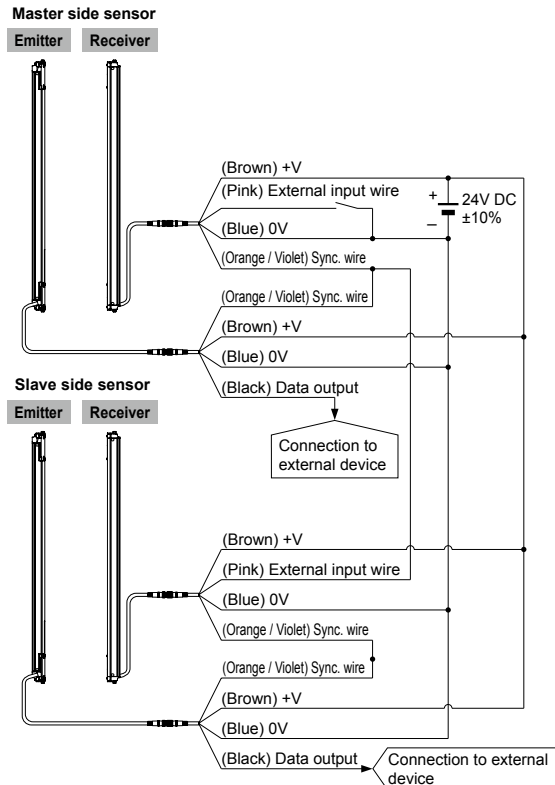

- Use with control board NB-64CB

### Use 1 set only

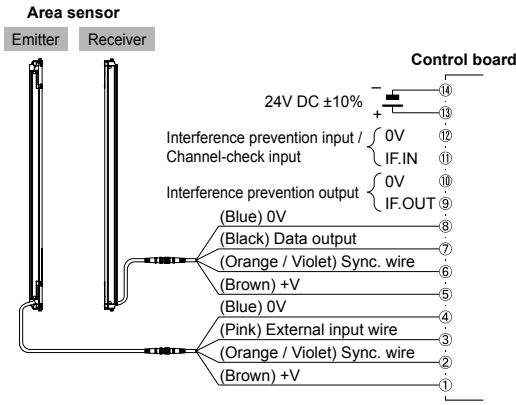

### Use two sets (using interference prevention function)

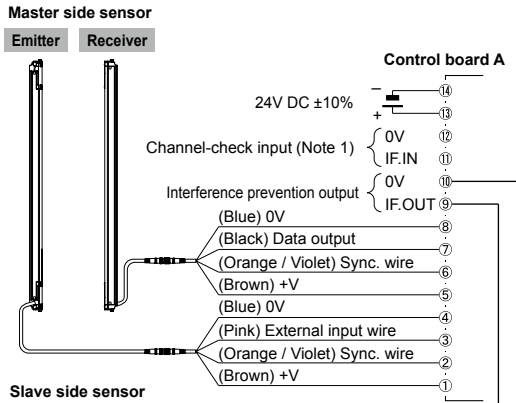

### Slave side sensor

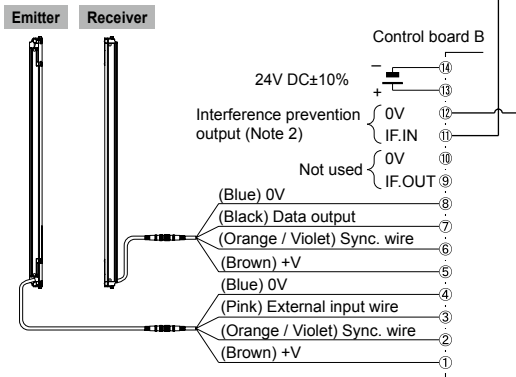

Notes: 1) Terminal No.11 and No.12 of control board A are used exclusively for the channel-check input.  
2) Terminal No.11 and No.12 of control board B are used exclusively for the interference prevention input. Terminal No.9 and No.10 of control board B cannot be used.

## 7 CHANNEL-CHECK FUNCTION

- Emission of all the beam channels is halted sequentially one after the other, beginning from Ch 1, when the external input (pink) of the emitter is held Low or the channel-check input terminals No.11 and No.12 are short-circuited on the NB-64CB control board. At that time, emission is stopped only for one channel while the other channels continue emission. And the stopping interval time is 4 scans (1 scan: approx. 5 ms). As a result, the corresponding channels on the receiver enter the dark state sequentially (each beam channels become OFF for 4 scans). This function can be used to check if all the beam channels are operable, or not, on start-up.

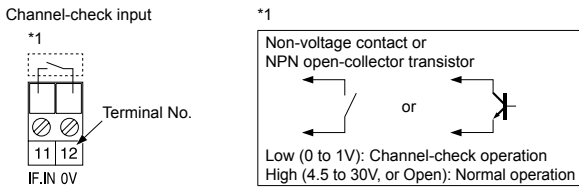

Note: In case using interference prevention function of area sensor only, connect external sensor input of master side to 0V.

- In case using interference prevention function, the emission of the beam channels of slave side sensor is halted sequentially too, beginning from Ch 1.
- While short-circuiting channel-check input terminal No.11 and 12 or keeping low the external input (pink) of emitter, channel check function are operated repeatedly.

## 8 DATA OUTPUT (In case of using area sensor only)

- The output of each beam is serially output in synchronization with the emitter synchronization signal.
- The output of the channel for which the beam is interrupted becomes "Low."

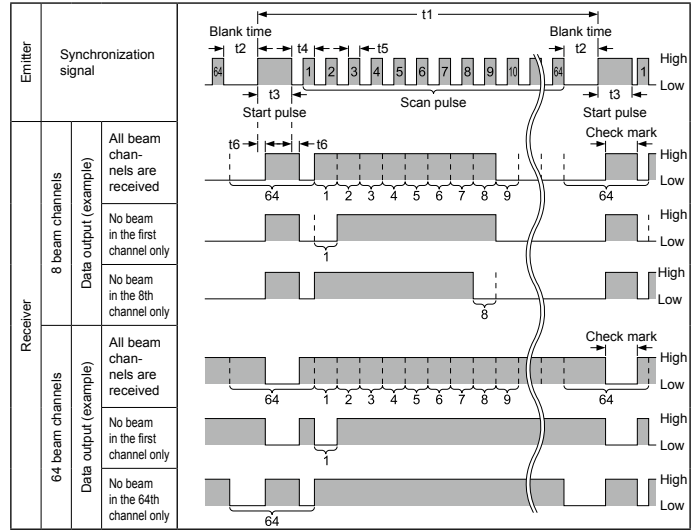
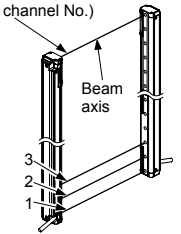

Channel-check function	t1	t2	t3	t4	t5	t6
Invalid		Approx. 5ms	Approx. 280µs	Approx. 210µs	Approx. 70µs	Approx. 35µs
Valid		Approx. 210µs	Approx. 280µs	Approx. 70µs	Approx. 35µs	Approx. 15 to 30µs

### • Scan pulse

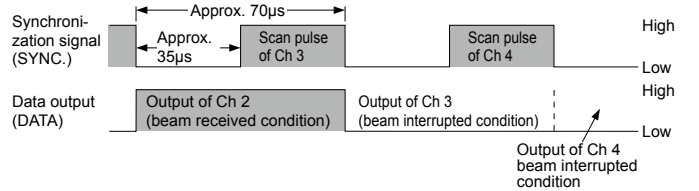

Note: The voltage levels for both SYNC. and DATA output are High: (Supply voltage - 1.1V) or more, Low: 1.1V or less.

## 9 SPECIFICATIONS

### Area sensor

#### • Different values in specifications

Type	20mm pitch type			
Model No.	NB-20-8	NB-20-16	NB-20-24	NB-20-32
Number of beam channels	8	16	24	32
Sensing height	140mm	300mm	460mm	620mm
Current consumption	Emitter 55mA or less Receiver 60mA or less		Emitter 70mA or less Receiver 75mA or less	
Weight (total of the emitter and the receiver)	Approx. 170g	Approx. 400g	Approx. 610g	Approx. 830g

Type	20mm pitch type			
Model No.	NB-20-40	NB-20-48	NB-20-56	NB-20-64
Number of beam channels	40	48	56	64
Sensing height	780mm	940mm	1,100mm	1,260mm
Current consumption	Emitter 85mA or less Receiver 90mA or less		Emitter 100mA or less Receiver 105mA or less	
Weight (total of the emitter and the receiver)	Approx. 1,000g	Approx. 1,300g	Approx. 1,500g	Approx. 1,700g

#### • Common values in specifications

Type	20mm pitch type	
Model No.	NB-20-□	
Control board for combination	NB-64CB, SF1-F64CB	
Sensing range	0.3 to 13m	
Beam pitch	20mm	
Sensing object	ø27mm or more opaque object	
Supply voltage	24V DC ±10% Ripple P-P10% or less	
Data output	Complementary voltage-driver output • Output format: Serial • Output voltage: High...(Supply voltage - 2.5V) or more, Low...1.5V or less • Maximum load current: 100mA	
Response time	10ms or less	
Protection	IP65 / IP67(IEC)	
Ambient temperature	-10 to +55°C (No dew condensation or icing allowed), Storage: -25 to +70°C	
Ambient humidity	30 to 85% RH, Storage: 30 to 95% RH	
Emitting element	Infrared LED (Peak emission wavelength: 870 nm)	
Material	Unit case: Aluminum, Both ends: Zinc die-cast, Inner case: Polycarbonate / Polyester, Cap: RBT	
Accessory	MS-SF2B-2 (Intermediate supporting bracket): (Note)	

Note: Intermediate supporting bracket MS-SF2B-2 is accessory of product listed below. the accessory number depends on product like below.

1 set: NB-20-40, NB-20-48, NB-20-56  
2 set: NB-20-64

## Control board

Model No.	<b>NB-64CB</b>	
Area sensor for combination	<b>NB-20□</b>	
Supply voltage	24V DC ±10% Ripple P-P10% or less	
Current consumption	300mA or less (including area sensor)	
Individual beam output	NPN open-collector transistor	
	<ul style="list-style-type: none"> <li>• Maximum sink current: 50mA</li> <li>• Applied voltage: 30V DC or less (between individual beam output and 0V)</li> <li>• Residual voltage: 1.1V or less (at 50mA sink current)</li> </ul>	
Number of channels	64 channels	
Output operation	Light-ON (channels of excess number of beam channels of area sensor is "OFF")	
Connector	Control board side connector: HIF3BA-40PA-2.54DC [HIROSE ELECTRIC CO., LTD.] Compatible connector (optional): HIF3BA-40D-2.54R [HIROSE ELECTRIC CO., LTD.]	
Response time	20ms or less (including the sensor's response time)	
Input (External interference prevention / Channel-check)	Input voltage: 0 to 30V	
	Input impedance: Approx. 5kΩ	
Ambient temperature	-10 to +55°C (No dew condensation or icing allowed), Storage: -10 to +70°C	
Ambient humidity	35 to 85% RH, Storage: 35 to 85% RH	
Weight	Approx. 200g	

## 10 CAUTIONS

- This sensor has been developed / produced for industrial use only.
- Use this product in stable light received condition (Incident light indicator: lights up in green).
- Make sure that the power supply is OFF while wiring.
- Make sure that all the wiring and connections are correct before supplying power. If power is supplied in miswired condition, the internal circuit may get damaged.
- Verify that the supply voltage variation is within the rating.
- If power is supplied from a commercial switching regulator, ensure that the frame ground (F.G.) terminal of the power supply is connected to an actual ground.
- In case noise generating equipment (switching regulator, inverter motor, etc.) is used in the vicinity of this product, connect the frame ground (F.G.) terminal of the equipment to an actual ground.
- Do not run the wires together with high-voltage lines or power lines or put them in the same raceway. This can cause malfunction due to induction.
- Do not use during the initial transient time (2 sec.) after the power supply is switched ON.
- The components on the control board may be damaged or degraded by electrostatic charge. Remove electrostatic charge from your body by earthing before handling the control board.
- The control board has no protection enclosure. The control board must be enclosed in a protective metal box, etc.  
If the control board gets wet or covered with dust, or if its components touch a conductor, it may get damaged.
- Take care that the sensor is not directly exposed to fluorescent light from a rapid-starter lamp or a high frequency lighting device, as it may affect the sensing performance.
- Make sure that stress by forcible bend or pulling is not applied directly to the sensor cable joint.
- Extension up to total 30.5m is possible with a 0.3mm<sup>2</sup>, or more of conductor cross-section area cable for both emitter and receiver.
- Install the area sensor where it cannot be affected by a beam reflected from a machinery frame or a workpiece. If the reflected beam is received, beam interruption is not achieved.
- This sensor is suitable for indoor use only.
- Avoid dust, dirt, and steam.
- Take care that the product does not come in direct contact with organic solvents, such as thinner, etc.
- This product cannot be used in an environmental contacting inflammable or explosive gasses.
- Never disassemble, repair and modify this product.

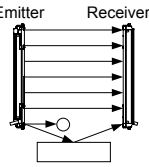

**Not good**

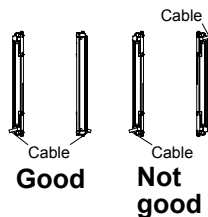

**Good**

**Not good**

## 12 DIMENSIONS (Unit: mm)

- Area sensor (Emitter and receiver)

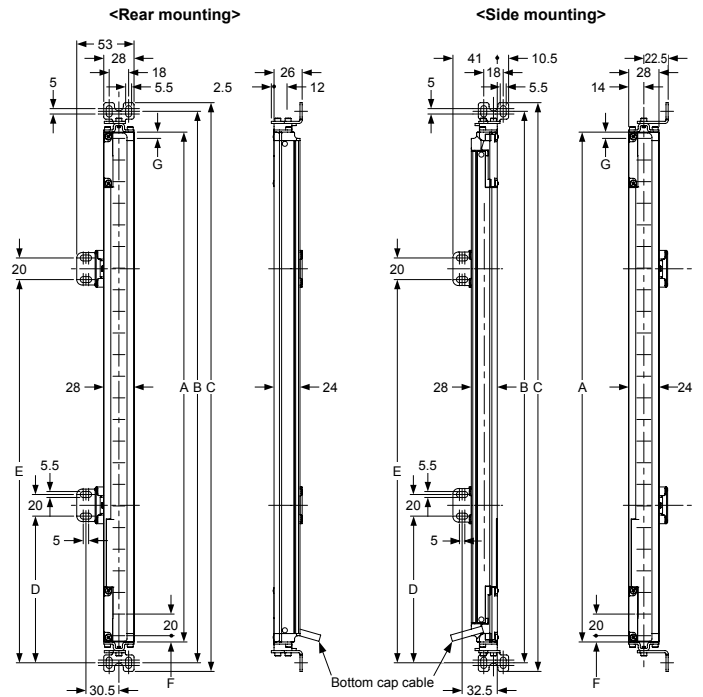

Model No.	A	B	C	D	E	F	G
<b>NB-20-8</b>	168	207	223	-	-	6	22
<b>NB-20-16</b>	312	350	366	-	-	6	6
<b>NB-20-24</b>	472	510	526	-	-	6	6
<b>NB-20-32</b>	632	670	686	-	-	6	6
<b>NB-20-40</b>	792	830	846	390	-	6	6
<b>NB-20-48</b>	952	990	1,006	470	-	6	6
<b>NB-20-56</b>	1,112	1,150	1,166	550	-	6	6
<b>NB-20-64</b>	1,272	1,310	1,326	418	842	6	6

- Control board

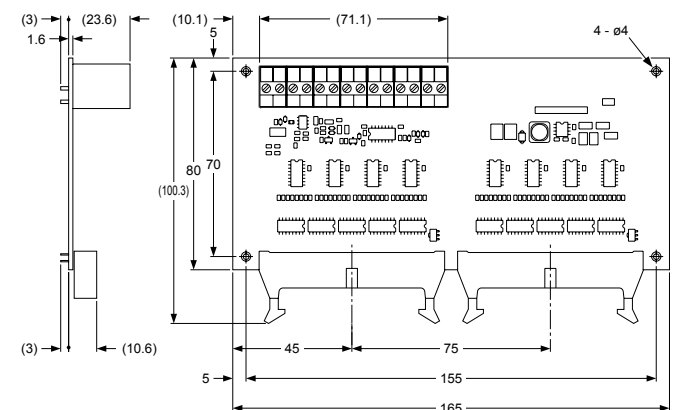

## 11 OPTION

Type	Model No.	Remarks
Bottom cap cable (discrete wire on one end)	<b>NB-CCB3</b>	Length: 3m Wight: Approx. 330g (2 pcs.)
	<b>NB-CCB7</b>	Length: 7m Wight: Approx. 700g (2 pcs.)
	<b>NB-CCB15</b>	Length: 15m Wight: Approx. 1,500g (2 pcs.)
Bottom cap cable (with connector on one end)	<b>SF2B-CB05-B</b>	Length: 0.5m Wight: Approx. 95g (2 pcs.) Cable for connecting to area sensor. This is used with connection cable <b>SF1-CC□</b> .
Connection cable	<b>SF1-CC3A</b>	Length: 3m Wight: Approx. 600g (2 pcs.)
	<b>SF1-CC7A</b>	Length: 7m Wight: Approx. 950g (2 pcs.)
Standard mounting bracket	<b>MS-SF2B-1</b>	Mounting bracket for rear or side mounting
Dead zone-less mounting bracket	<b>MS-SF2B-3</b>	Mounting bracket for no dead zone mounting
Compatible mounting bracket	<b>MS-SF2B-4</b>	Used for replacing from <b>SF1-F</b> series (4 pcs. for 1 set)
	<b>MS-SF2B-6</b>	
	<b>MS-SF2B-7</b>	

## Panasonic Industrial Devices SUNX Co., Ltd.

<http://panasonic.net/id/pidsx/global>

Overseas Sales Division (Head Office)

2431-1 Ushiyama-cho, Kasugai-shi, Aichi, 486-0901, Japan

Phone: +81-568-33-7861 FAX: +81-568-33-8591

About our sale network, please visit our website.

PRINTED IN JAPAN

© Panasonic Industrial Devices SUNX Co., Ltd. 2013